

Owner's Manual
for your new

Jupiter Science JP1000 Water Ionizer



EMCO TECH CO.,LTD
www.royalwater.com

Importer



Warning: Incorrect installation and/or operation could void your valuable warranty.
Please protect your investment! READ THIS MANUAL CAREFULLY

CONGRATULATIONS ON YOUR NEW PURCHASE!

You have just purchased the finest, most advanced water system in the world! Your new ionizer is designed to provide you with many years of the cleanest, healthiest and most "functional" water available. There are many specific uses and benefits of this amazing water, so read this manual carefully to learn how to get both optimum performance out of your ionizer and to protect your investment.

Your new Jupiter Science JP1000 produces filtered alkaline, ionized water. Just exactly what is that? Your ionizer employs computer accurate and selectable magnetic energy to perform electrolysis through patented platinum bonded titanium electrodes inside a water cell. Inside this advanced cell, the magnetic energy separates the water into an alkaline (high pH) and acid (low pH) stream without using any chemicals. Ionizing the water in this way re-structures the molecules and reduces their cluster size, binds extra oxygen molecules, and concentrates ionized, absorbable and beneficial minerals like Calcium, Magnesium and Potassium.

Your new Jupiter Science JP1000 also produces Acidic water. This type water is low in pH, less than pH6 and has many excellent uses. You will now have the convenience and benefits of water that "functions" in many ways that ordinary tap, filtered or bottled water cannot.

TABLE OF CONTENTS

Dear Customers	01-02
Important safety warnings and precautions	03-08
Lets take a tour of your JP1000 !	09
Description of main body	10
Your control panel	11
Description of control panel features.....	12
Accessories	13
Installation procedure	13-14
Operation	15-16
Performance and measuring pH	17
How to add calcium	18
How to replace your filter	19-20
Some uses for alkaline and acidic water	21-22
About your biostone filter	23-24
Trouble shooting guide	25-26
Product specifications	27
Warranty card	28

IMPORTANT SAFETY WARNINGS AND PRECAUTIONS

※WARNING: Please read these pages carefully.
They contain very important information to keep YOU and your new ionizer safe!
When using your Melody, especially when children are present, basic safety precautions should always be followed, including the following:

ELECTRICAL PRECAUTIONS AND SAFEGUARDS

 NEVER attempt to repair or service the unit yourself. Attempting to do so will void your valuable warranty! Contact your dealer to arrange service or repair.



 If your ionizer becomes submerged in water, unplug the power cord from the wall before removing the ionizer from the water. Failure to do so may cause electric shock!

 Do not use your ionizer at voltages other than specified (AC 110V FOR USA). Use a GFI outlet. Do not plug in your ionizer where it will exceed the rating of outlet or electric wiring. Failure to do so can result in fire, injury and/or damage to yourself, wiring or ionizer!

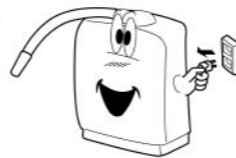

 NEVER touch the power cord or plug with wet hands – this may result in electric shock!



 Do not wash your ionizer by immersion or by pouring water over the main body; always unplug your ionizer while cleaning the casing. Clean with damp sponge or cloth.

 Ensure the power plug is firmly and properly inserted into the outlet – failure to do so may result in electric shock or fire!

 Keep the power cord and your ionizer away from hot surfaces or appliances – failure to do so may result in electric shock or fire!

Do not operate your ionizer with a damaged power cord or plug or insert into a faulty or worn outlet.

Never insert foreign objects into your ionizer.

Installation Precautions

 Protect your ionizer from freezing temperatures.

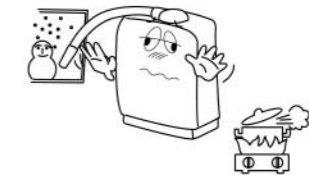

 Protect your ionizer from direct sunlight.

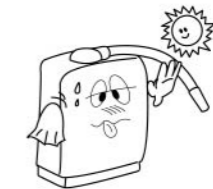

 Do not put anything heavy on top of your ionizer. Do not install your ionizer on an unstable or soft surface. Install only on a hard and level surface.

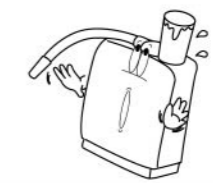



IMPORTANT SAFETY WARNINGS AND PRECAUTIONS

Maintenance Precautions

 Always unplug your ionizer when changing the fuse or cleaning your ionizer – failure to do so may result in electric shock.

Common Sense Precautions

 Do not attempt to repair or service the unit yourself. Contact your dealer. Attempting to do so will void your valuable warranty!

 Make sure to use your ionizer only with potable water which is suitable for human consumption.

 DO NOT use your ionizer with well water, water with extreme hardness, high sediment or TDS levels without first consulting your dealer.

During Use

 Do not run hot water through your ionizer.



 Do not clean by pouring water over or spraying the ionizer.



 Do not close, bend, pinch, press or otherwise obstruct output ports or hoses.

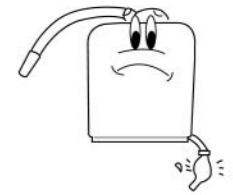

 If the appliance makes strange or unusual noises or burning smells are detected, unplug the power cord immediately and contact your dealer to arrange service.

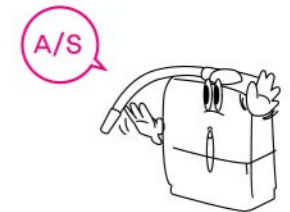

 Unplug your ionizer if you plan not to use it for an extended period or turn off the main power switch on the back of the unit. Filter replacement may be necessary.

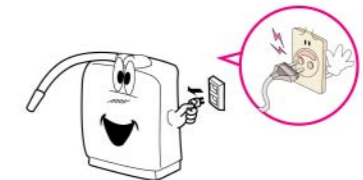

pH Reagent Liquid Precautions

-  Do not expose the pH measuring reagent to extreme heat, flames or fire. It is combustible.



-  Do not drink the pH reagent liquid, put it in the eyes or apply to the body.

- If the liquid is ingested, induce vomiting immediately and call a doctor.
- If the liquid gets in the eyes, flush immediately and thoroughly with cool water; call a doctor.
- If spilled or dropped on your body, wash it off immediately.



Make sure to keep the pH reagent liquid tightly closed and out of the reach of children.

Precautions for use of Alkaline water – don't develop a "drinking" problem!

- If you have never consumed alkaline water – do not use a setting higher than 1 to begin with. Let your body adjust slowly and naturally for 4–7 days. After this initial adjustment period, you can gradually increase the alkalinity of the water.
- Do not take medications with alkaline water. Take medications only with purified water.
- Consult with a physician before drinking alkaline water if you have:
 - Chronic disease
 - A dysfunctional liver or intestines
 - Are currently under medical treatment
- Do not drink alkaline water if you have achlorhydria.
- Consult a physician before using acidic water if you have:
 - Sensitive skin
 - Allergies
- Only use potable drinking water in your ionizer.
- Poor water quality may have negative effects on your health and your ionizer! Most municipal water sources will be fine in your ionizer.
- Well water and water from smaller systems should be checked, and may require pre-filtering. Your ionizer is not under warranty for any damage or required cleaning caused by hard water deposits.

Some helpful tips

-  For storing your alkaline water, glass or ceramic is best. Always try and keep your stored water cool and away from direct sunlight. You can use plastic, but only use lexan (number 7) or poly bottles (Nalge type). It is always best fresh out of the machine and ideal if consumed on a day–today basis.



-  Do not store alkaline water in stainless steel, bronze or aluminum containers.

-  Save the box and Styrofoam your ionizer came packed in. This will help if your ionizer needs to be transported at a later date.

-  Do not use an ionizer downstream of a sodium–based ion exchange softening system or Reverse Osmosis system without first consulting with your dealer.

Safety Precautions

Please read these pages carefully. They contain very important information to keep YOU and your new ionizer safe!



Warning

Property damage, serious injury or death may result if these instructions and precautions are not observed.

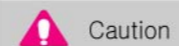

Caution

Physical injuries or material damage may be caused if the instructions are not observed.

Do's and Don't's



DO NOT



Do not disassemble it.



Disconnect the power cord from the wall outlet.



DO



Do not touch it.



Ground product for protection from electric shock.

LETS TAKE A TOUR OF YOUR JP1000

DESCRIPTION OF MAIN BODY

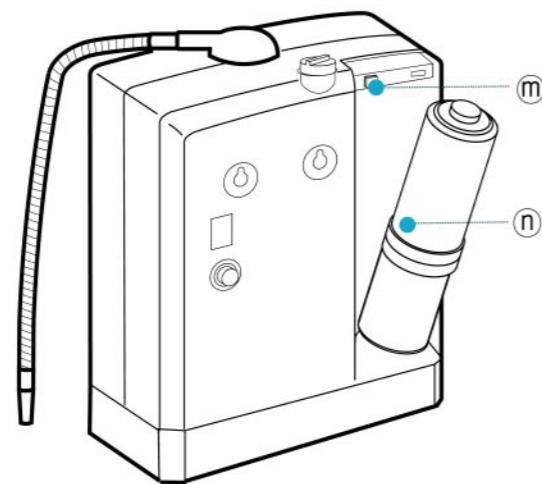
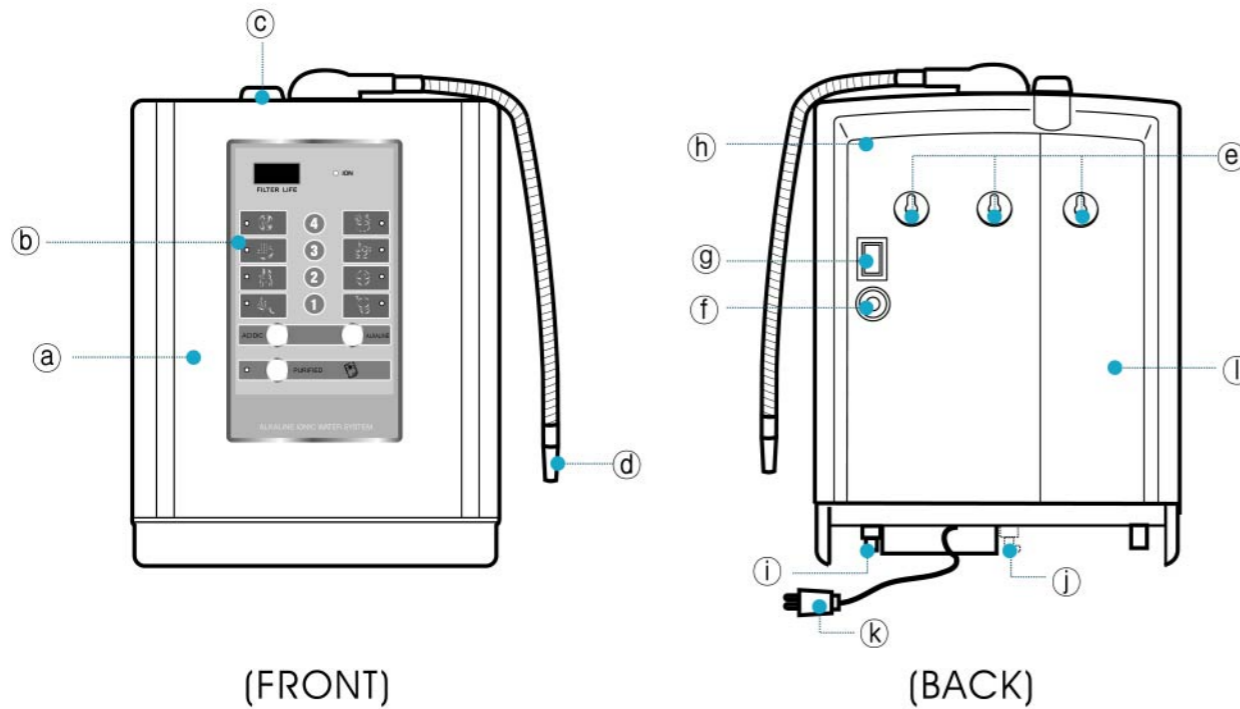

- a Main Body**
Easy to clean and durable plastic casing protects your ionizer.
- b Control / LCD Display Panel**
Controls and function indicators are detailed on Page 5 of this manual.
- c Calcium Insert Port.**
This is where you can add the optional Calcium. Note: IonLife recommends that only those in soft water areas, or in situations where pH is not properly elevated utilize this feature.
- d Flexible stainless steel drinking water spout**
You will get your drinking water from this spout. It is flexible to accommodate proper positioning.
- e Key-hole Slots For Wall Mounting**
To save counter space you can mount your ionizer on the wall. Note: use suitable fasteners.
- f Fuse Holder**
Your ionizer comes equipped with a fuse to protect it in case of power surge or fluctuation.
- g Main Power Switch**
You will use this switch on the back to turn on and off the power supply to your ionizer.
- h Back-Cover Panel.**
You will use this switch on the back to turn on and off the power supply to your ionizer.
- i Acidic Water Outlet Port.**
This is labeled with a red sticker and is where the acidic stream will exit your ionizer.
- j Tap Water Inlet Port.**
This is labeled with a blue sticker and is where the tap water will enter your ionizer.
- k Power Cord.**
This is your 110v AC power cord. Always use a GFI outlet in good working order.
- l Filter Housing Door**
You will open this door to access and change your filter and reset your filter life indicator.
- m Reset Button.**
Depress this button until your digital filter life indicator resets to 0000.
- n Filter Cartridge.**
Replace this after the digital filter life indicator reaches 9999.

YOUR CONTROL PANEL

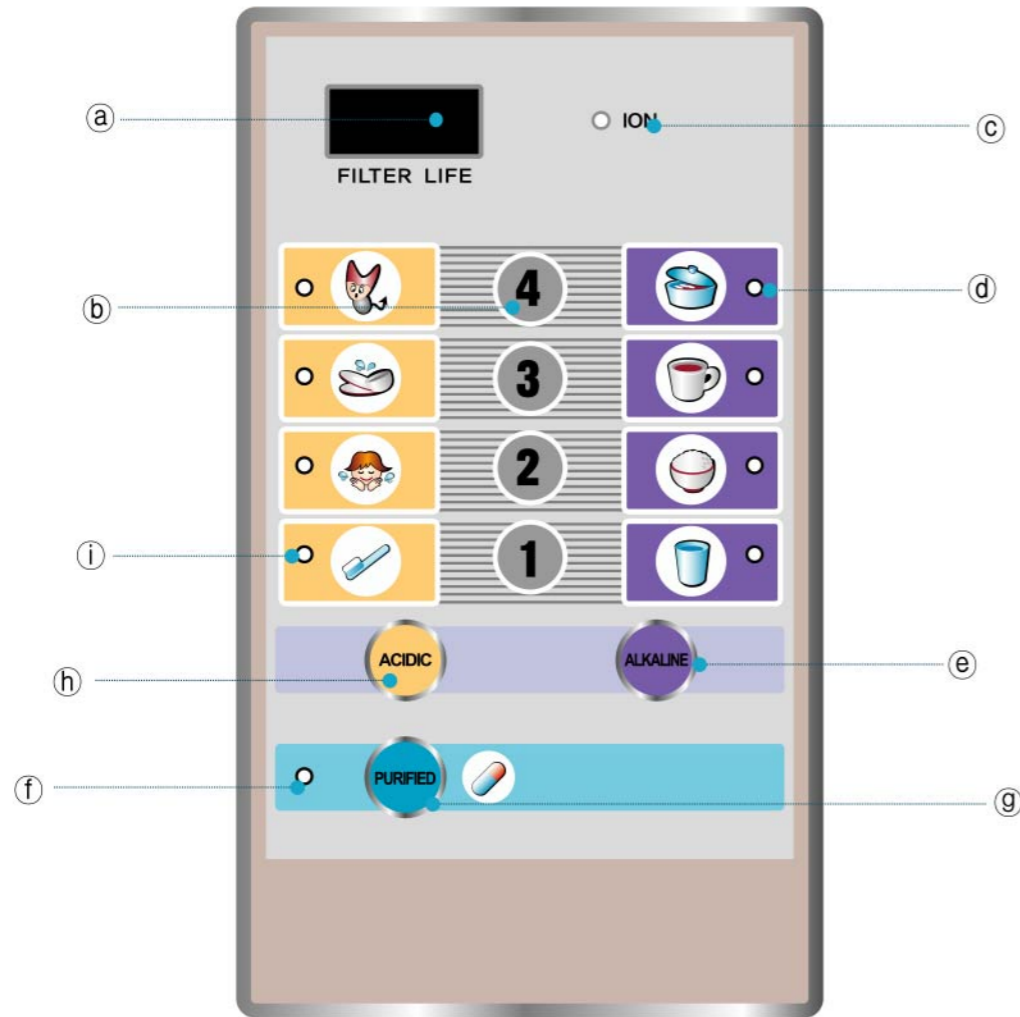

CONTROL PANEL

DESCRIPTION OF CONTROL PANEL FEATURES

PLEASE NOTE: Your panel will light up in Indigo Blue, Green or Red to indicate which function you have selected – Alkaline, Purified or Acidic respectively.

a Digital Filter Life Indicator

The machine is equipped with a sensor to detect the quality of source water and usage. The digital display indicates the filter life / usage with numbers progressing from 0000 – 9999. When the indicator reaches 9999, it is time to replace your filter.

b pH level Selection Button

The buttons for selecting an intended pH level from 1 to 4.

c Ionized Water

To indicate generation of acidic and alkaline water.

d Alkaline Strength Level LED

To indicate an alkaline water usage (or pH level) selected by a user.

e Alkaline Water Button

For selecting an alkaline water output.

f Purified Water LED

Led indication purified water function selected.

g Purified Water Button

An user can enjoy only purified water by filtering just as a water purifier. In this mode, ionized water is not available.

h Acidic Water Button

For selecting an acidic water output.

i Acidic Strength Level LED

To indicate an acidic water usage (or pH level) selected by a user.

ACCESSORIES

Before installation, please check to ensure you have the following accessories. Please note that the diverter and adapters accommodate the vast majority of standard faucets. If you have a non-standard or custom faucet you may need to locate and purchase additional parts.

Install Kit (Divertor and adapters)



Diverter / Hose clamps / Adapter

Accessories

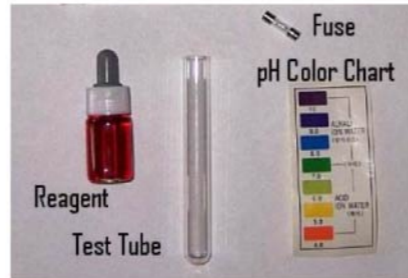

Reagent / Test tube
fuse / pH color chart

INSTALLATION PROCEDURE

- 1. ATTACH THE DIVERTER TO YOUR TAP –**
Remove the aerator from tap (pliers may be required), and attach diverter valve in its place (see photo below). There are adapters supplied in case the diverter does not fit your tap. **DO NOT OVERTIGHTEN.** If you have leaks at the diverter, use a few wraps of plumber's Teflon tape which is available at any hardware store for a couple of dollars.
- 2. ATTACH THE WHITE HOSE TO THE TAP WATER INLET PORT –**
First, slide a squeeze clamp over one end of the white hose. Then attach the white hose, by simply pushing it firmly over the white plastic port labeled TAP WATER INLET on the bottom of your ionizer. Squeeze the clamp and position it over the white port.
Installation Tip: Soaking the hose in hot water for 30 seconds will make attaching it very easy.

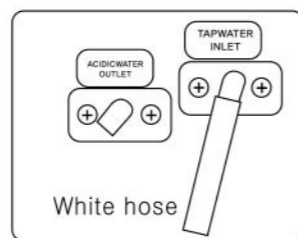
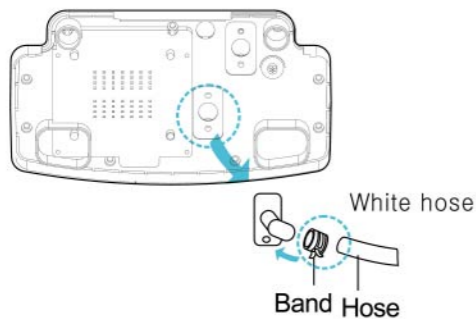

INSTALLATION PROCEDURE

- 3. ATTACH THE GRAY HOSE TO THE ACIDIC WATER OUTLET PORT –**
First, slide a squeeze clamp over the end of the hose. Then attach the gray hose to the white plastic port labeled ACIDIC WATER OUTLET on the bottom of the ionizer.
Simply push the hose firmly over the white plastic port. Squeeze the clamp and position it over the white port. Ensure the opposite end runs into the sink.

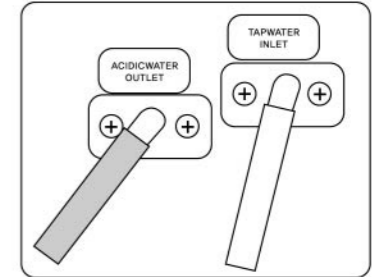

- 4. POSITION YOUR IONIZER –**
Ensure it is on a hard and level surface. A wall mount can be done – there are keyhole slots on the back for this.

- 5. ATTACH THE WHITE HOSE TO THE DIVERTER –**
Remove the small compression nut on the back of the diverter (opposite of the lever). Slide the nut over the opposite end of the white hose you attached to the TAP WATER INLET port with the threads positioned so the nut will screw back onto the diverter. Push the hose firmly onto the nipple. Firmly screw the compression nut back on. Do not over tighten.



- 7. CONNECT THE POWER CORD** to an appropriate GFI outlet.
- 8. INSTALL FLEXIBLE STAINLESS STEEL SPOUT**
– Screw this into the threaded port on the top of the ionizer. Do not over tighten.

OPERATION

1. POWER UP YOUR IONIZER.

- Depress the black power button located on the back of the ionizer to the "ON" position.
- The black power button is ALWAYS left on. Your ionizer will "go to sleep" in between uses and "wake up" when it detects water flow again. It will always return to your last selected setting.
- You will hear a single chime and the display panel will illuminate for 2-3 seconds.
- With the power on and the display panel dark, your ionizer is now in standby mode.

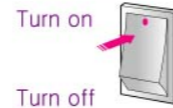

2. START WATER FLOW THROUGH YOUR IONIZER

- A. Turn on your water faucet.

Important: This is a critical aspect of controlling your ionizer's performance.

Please view the "Adjustment" section of the DVD.

The Flow Rate of the water out of your faucet WILL DIRECTLY impact the performance of your ionizer. A slower flow will yield higher pH; a faster flow will yield lower pH.

- B. Turn the lever to on your diverter to "divert" the water through your ionizer.

IMPORTANT – WHAT YOU WILL NOTICE:

Water will now come through the two output hoses.

The water will initially be discolored. This is carbon dust.

Allow the water to flow for 2-3 minutes to flush out the filter.

This is not harmful and is typical of all carbon filters.

Your Ionizer will start up in Cleaning Mode each time you use it.

To indicate this the Acidic Water Indicator on the Control Panel will be illuminated and your ionizer will be playing a tune. The cleaning mode will run from 10 – 30 seconds and will automatically shut itself off when complete.

When complete the tune will stop playing.

Important: YOU ONLY NEED TO RUN THE COMPLETE CLEANING CYCLE ONCE A DAY!

Once the Cleaning Cycle is complete, you can select the desired water type.

OPERATION

3. TO SELECT ALKALINE WATER

- A. Start Water Flow through your Microlite.
Remember, it will always start in Cleaning Cycle indicated by the tune and the Acidic Water Indicator being illuminated.
- B. After it has completed one full Cleaning Cycle (we suggest first use in the morning), then you can BYPASS the Cleaning Cycle by depressing the "ALKALINE" button to select the desired setting. Each time you depress the ALKALINE button, the Alkaline Water Indicator LED will illuminate and the pH Level Indicator will move up and down the scale to the indicate the selected level.
- C. Note: Your Microlite will always "remember" the last setting. For instance, if the previous setting was Alkaline Level Medium, then it will go back to Medium when you start the ionizer and bypass the Cleaning Cycle by depressing the ALKALINE button once.
- D. To select a different level, depress the "ALKALINE" button to move to next level until the desired setting level is achieved. The pH Level Indicator will change accordingly.

IMPORTANT NOTES:

-If you have never consumed alkaline water – do not use a setting higher than LOW to begin with. Let your body adjust slowly and naturally for 4-7 days.

After this initial adjustment period, you may gradually increase the alkalinity of the water.

-pH levels will vary according to the minerals present in the source water and water flow rate through your ionizer.

4. TO SELECT ACIDIC WATER

Note: Acidic water is for external use only. **DO NOT DRINK.**

1. With water running through the ionizer:
2. Depress the "ACIDIC" button. The Acidic Water Indicator will light and the pH Level Indicator will move up and down the scale to indicate the selected level.
3. To select a different level, depress the "ACIDIC" button to move to next level until the desired setting level is achieved. The orange symbol and number will change accordingly.

5. TO SELECT "PURIFIED" WATER

With water flowing through the machine, depress the "PURIFIED" button.

The Purified Water Indicator will be illuminated. "Purified Water" runs through the Biostone filter, but does not receive any ionization. The purified water comes out of the stainless steel spout.

Nothing comes out of the acidic outlet.

HOW TO SHUT OFF THE WATER FLOW FROM YOUR IONIZER

Rotate the diverter lever until the water flow from the ionizer stops and reverts to the faucet.

The water will stop and the LED Indicator panels will go dark indicating the ionizer is in standby or "asleep".

PERFORMANCE AND MEASURING pH

How to Measure pH

- 1) Fill one of the test tubes provided with about 1 inch of alkaline, acidic or purified water.
- 2) Place 2 drops of the pH reagent into the tube and shake it. If the reagent and water are not mixed well, the correct result may not be achieved. Too many or too few drops will effect results.
- 3) The pH value is determined by matching the color the pH color chart provided.
- 4) Keep the pH indication reagent in a dark and cool place. DO NOT expose to sunlight or heat.

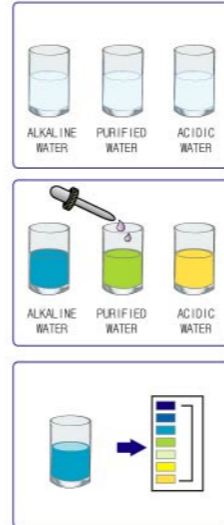

THE PERFORMANCE OF YOUR IONIZER (VERY IMPORTANT INFORMATION!):

- * There are three primary factors that control the performance of your ionizer:
 - 1) The quality of your source water and its mineral content. We can not control this factor.
 - 2) The voltage being applied to the minerals in the water. You control this by selecting the Alkaline level on the control panel. The higher the setting the more voltage or power is being applied to the water.
 - 3) The flow rate of water through your ionizer. You control this with the Flow Control knob on the control panel. This determines how long the water is being processed. With a fast flow your ionizer will produce lower pH, with a slow flow it will produce higher pH.
- * Water quality and mineral content vary greatly in different localities. Generally in "hard water" areas where mineral content is higher, your ionizer will easily reach high levels of pH even with a faster flow. In "soft water" areas where mineral content is lower, your ionizer may only reach the higher levels of pH with a slower flow.
- * Learn to use the pH test kit and be sure to test your source water. Also test the water produced at teach Alkaline setting at various flow rates.
- * If your source water tests at a very low pH, you may want to "boost" performance by adding a coral calcium cartridge into the Calcium port at the top of the ionizer (see the next section).
- * Do not drink the water that has been tested with the pH testing solution.

HOW TO ADD CALCIUM

How to add calcium

- 1 Stop the water flow prior to calcium replacement.
 - Water will overflow if you open the calcium cap while water is coming out.

- 2 Unscrew the cap to the left and remove.
 - The first time you remove it the cap may be tight. Use a butter knife to work it free.

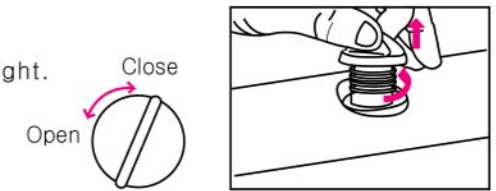

- 3 Take the basket apart from the cap and dispose of the remaining beads. The beads never completely disappear
 - it's the calcium coating on the beads that slowly releases into the water. Beads will release calcium for about 1-2 months depending on amount of use and pH of water.



- 4 Wash the basket and remove all water.



- 5 Add the new calcium beads and close the cap.

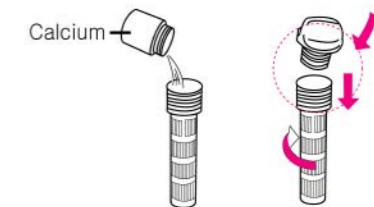

- 6 Insert the basket into the calcium port and twist the cap closed.

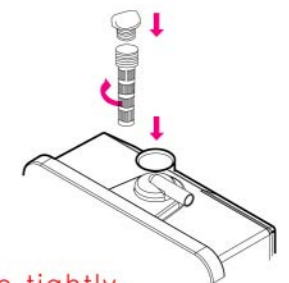

WARNING! Water will overflow if you do not close the cap tightly.

HOW TO REPLACEMENT THE FILTER

IMPORTANT! Stop water flow prior to filter replacement.



How to Replace the Filter

- 1** When the digital filter life indicator reaches '9999' it is time to replace your filter. You will also want to replace your filter if any of these situations occur:

- Severely reduced flow rate – slower than usual even with full flow on the control valve.
- Abnormally bad taste – usually due to a sudden change in quality of source water.
- A period of inactivity of over one month – for instance an extended vacation.

- 2** Open the filter housing cover.

- Push in on the plastic ridges in the center of the filter housing cover on the side while pulling the door out and to the left. Swing door out and remove it.

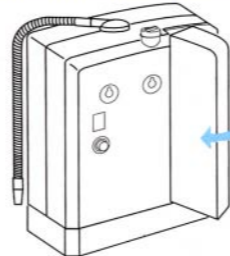

- 3** Remove the expired filter.

- Taking hold of the filter securely with your right hand, press the filter firmly down against the spring loaded mechanism to disengage the top of the filter and then pull it toward you and up to remove it.
- The upper part of the filter is separated from housing by pressing firmly down. Once you have engaged the spring loaded mechanism, you can then easily remove the filter from the main body by pulling it toward you.



- 4** Insert the new filter into the compartment.

- Remove the plastic caps covering both ends of the new filter.
- Seat the large opening on the bottom of the filter cartridge onto the base.
- Push the filter down and into the housing compartment ensuring the opening at the top of the filter is seated properly into the fitting at the top of the housing

- 5** Check for leaks by running water through your ionizer before replacing the housing cover.

- 6** Flush out the GAC carbon dust.

- The water will initially come out discolored (light to charcoal gray) due to carbon dust in the new filter. This is not harmful and is typical of all GAC filters. Allow the water to flow for 2-3 minutes in the "Purified" mode and this will flush all the carbon dust.

- 7** Reset the filter life indicator.

- With your Melody in standby mode (water not running through the ionizer) press the "Reset" button located at the top of the filter housing compartment until the counter resets to 0000.

- 8** Replace the filter housing cover.

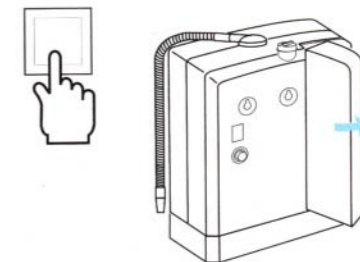

WARNING INDICATORS

- 1) **LOW PRESSURE** – The Low Pressure Warning indicator will flicker when water flow or pressure into the machine is weak. Increase the water flow to resolve this condition.
- 2) **HOT WATER** – The Hot Water Warning indicator will flicker when you have inadvertently run hot water into the machine. Switch back to cold water immediately to resolve this condition. Allow the cold water to flow for about a

SOME USES FOR ALKALINE AND ACIDIC WATER

Some uses for the different levels of Alkaline water

Alkaline water:

Note: pH levels will always vary with different source water.



1

For initial consumption period (4-7 days). Let your body adjust slowly to the increase in pH. Many people find that this lower level is actually perfect for them.



2

After the adjustment period you can drink the water at this next level. This level is also great for cooking rice and other grains - fluffier and great tasting!



3

Some people like this for drinking though it can start to taste strong. It is superb for making tea or coffee as it enhances the taste and reduces bitterness!



4

Generally most people find this very strong tasting and with powerful detoxifying effects. Great for boiling vegetables! Alkaline water will eliminate the bitter taste and brings out more of their natural color.

Some uses for the different levels of Acidic water

The Acid water has both antiseptic and antibacterial properties. It also has an astringent effect and can be used for cosmetic purposes.



1

Use it while brushing your teeth, gargle with it and use it as a natural mouth wash!



2

It is an excellent astringent; use it for washing your face or as a natural after shave.



3

In the kitchen use it to help clean kitchen utensils.



4

This setting has sterilizing properties - use it to sterilize cutting boards, dish towels etc...

What would I use the Purified water for?



The pH of Purified water is neither raised nor lowered and would be the same as your tap water. This water is simply cleaned of impurities by the advanced filtration system. You can use it both as drinking water and to take medications with.

About your Biostone Filter

Composition of filter

Calcium:
It slightly increases the alkaline mineral content in your water. It improves water taste and odors, and it is particularly effective in removing the chloride. You get coral calcium on tap!

Tourmaline:
Tourmaline emits Far Infra Red (FIR) energy naturally. FIR produces well documented health benefits and it also has an amazing effect on water. The Biostone contains the semi-precious gemstone tourmaline in ceramic form, so you get FIR on tap!

Non-woven fabric filter
Filters out sediment and particulate.

Granular Activated Carbon (GAC) :
The workhorse of the filtration media. GAC is especially effective at removing chlorine, its odor and taste, agricultural chemicals, phenol, trihalomethane and other chemical contaminants. Silver is coated on the surface of the granular activated carbon to inhibit bacterial growth in between use.

Non woven fabric filter :
Filters out sediment and particulate.



Flow Diagram

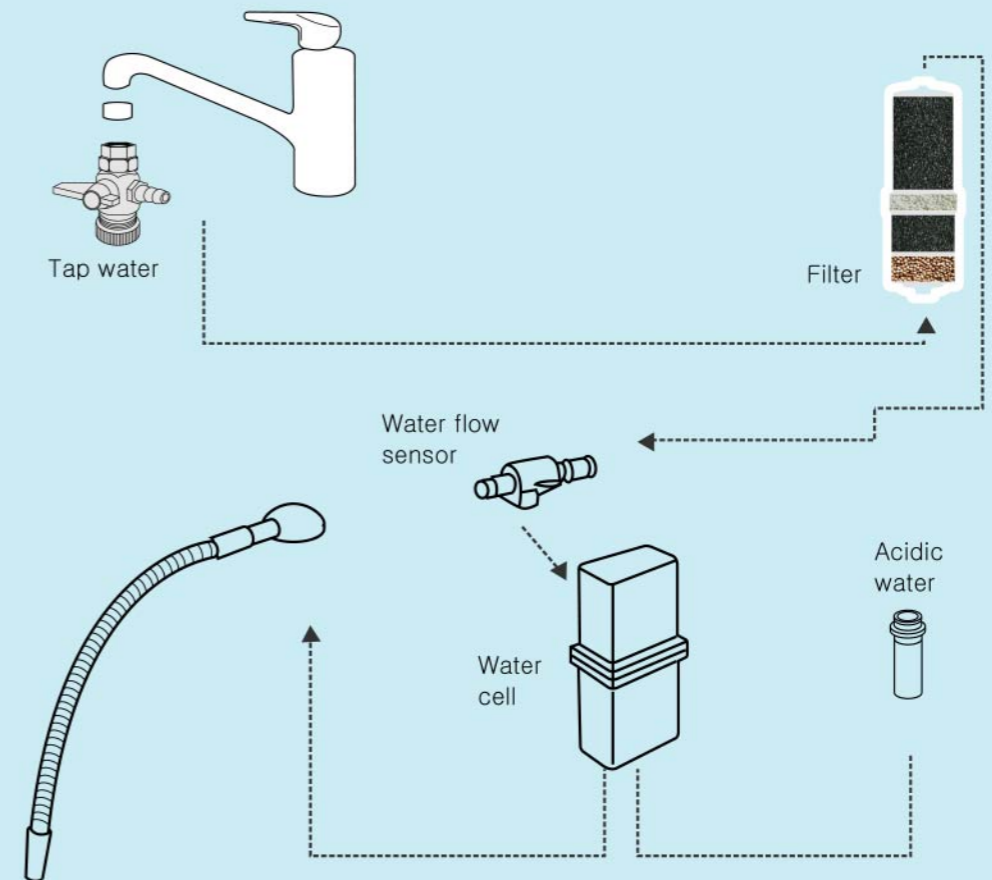

Trouble Shooting Guide

Abnormal condition	Cause(s)	Resolution
The Function Display Panel does not come on.	A power plug is not properly inserted, or it is inserted into a faulty outlet.	Properly insert power plug into a correctly functioning power outlet
	The fuse is blown. The fuse is not inserted properly.	Replace the fuse. A spare fuse is included in your reagent kit. (3A / 250V fuse)
The Function Display Panel / display indicators do not come on even after turning the tap on.	Faulty PCB (Printed Circuit Board)	Immediately unplug the unit and contact your dealer to arrange service.
pH test shows alkaline water color as neutral (7) while acidic water color gets yellow (6). This is normal if initial pH is 6.5	Faulty or evaporated reagent: alkaline / acidity are always produced in inverse proportion. Therefore, showing an acidic color means inversely that alkaline water has to be generated from the unit. Lack of alkaline color can result from a chemical reaction where carbonic acid in water evaporates some test reagent elements.	Test pH value on level 3 or 4 water; replace reagent.
Power supply is suddenly cut off while operating the unit.	Elevated level of salt in the water or high TDS: extended operation at high pH: sudden flux in electrical current. In these cases your machine will shut down automatically to protect the electrodes and circuitry.	Wait – the unit will become operational again after about one hour. Your ionizer has a safety mechanism built-in to protect the electrodes and circuitry. This mechanism will shut the ionizer down automatically. This mechanism protects the unit from overuse or excessive electric current.
Low output of alkaline water from the unit.	Filter is clogged. Premature clogging may be caused by sudden drop in water quality and an influx of sediment or other contaminants, which stress the filter.	Replace your filter. Clean Pre-filter
	Low pressure in your household plumbing.	Ensure water supply valves are fully open. The water pressure in house may be too low.
	The input hose is bent, kinked or otherwise restricted.	Straighten the bent hose.

Abnormal condition	Cause(s)	Resolution
Strange smell from Alkaline water.	Expired filter from ordinary use or premature clogging due to flux in water quality.	Replace your filter.
	Sudden flux in water quality with elevated level of Choline (not Chlorine). Elevated Choline levels are observed in some areas during summer months. These levels fall within safe drinking water standards, yet will cause a reaction with ionized water causing a unique smell.	Select lower pH level (1-2). If still present, filter replacement may be necessary.
Water appears milky: white snow like particles in the bottom of your glass.	You have high hardness (calcium primarily) in your water. The white is extracted CaCO ₃ (Calcium carbonate). After CO ₂ in water is bonded with Ca where elevated levels of CO ₃ exist in your water. In water where elevated levels of CO ₃ exist, what you see after ionization is CO ₂ in the water bonded with Ca.	This is calcium! It is not only harmless, but actually good for you. Remember the ionizer separates and condenses the alkaline minerals and this is what you are seeing. You can lower the setting (1-2) and reduce this effect. Typically this only occurs in hard water areas.
At first no smell, but then smell from the alkaline water about one hour after.	Your water bottle or receptacle is foul and needs cleaning. Contamination mixes with alkaline water when filling your bottle. Expired filter.	Clean your bottle or receptacle. Try selecting lower pH level (1-2). Replace your filter.
Water leakage from the filter cartridge housing.	Filter not installed correctly into filter housing.	Remove your filter and reinstall it properly following the filter replacement instructions. Increase the quantity of source water inflow.
No acid water flow from the acidic output port.	Acidic output hose is bent, kinked or otherwise restricted.	Straighten the bent hose; increase water flow from supply.

Water Ionizer Limited Warranty

Product Specifications		
Product Manufacture Permission Number	No.610 by The Ministry of Health & Welfare	
Feature	Ion water generator	
Model	JP-1000	
Input voltage	AC120V / AC220V / AC230V / AC240V	
Input Electricity(Power consumption)	0.5A(110W)	
Weight	Approx 15.9 lbs	
Overall Dimention	265 X 140 X 321mm	
Applicable Water Inflow Pressure	1.5 lbs ~ 11 lbs / 0.7~5kgf/cm ³	
Applicable Water Temperature	41 ~ 86F / 5~30 °C	
Unit Operation Type	One Touch - Automatical ionization Start	
Unit Operation Means	Tap - water - open and - close	
Electolysis Device	Electrolysis Method	Continuous electrolysis
	Alkaline Settings	1-2-3-4 level
	Ionized Water Output Rate	Max 3 Liters/minute(alkaline+acidic water)
	Cleaning Device	Automatic & Manual cleaning
	Electrode Materials	Platium and Titanium
Water Purifying Device	Filter Replacement	Easy replaceable cartridge
	Filter Life	Activated Carbon filter:approx 5~6 months basic 20 Liter/day
	Filter Life Indicator	FND indication
	Filter Composition	Silver impregnated activated Carbon and bio ceramic stone, coral calcium + Tourmaline space fibre ultra fine (optional)
Water Purifying Device	Temperature sensor / Auto Shut off	
Water Supply	Direct connection to a tap	

Limited two year warranty

Customer is responsible for shipping charges to authorized repair facility.

If repair is necessary during warranty period, the purchaser will be required to furnish a proof of purchase indicating the date.

When shipping the unit, use original packaging if possible, or sufficient packing material and appropriate box.

Include a letter detailing your return address, phone number and the reason for service.

Name: _____

Address _____

Address _____

City _____ State _____ Zip _____

Contact Phone number (_____) _____

This warranty is extended only to the original purchaser.

This warranty only covers failures due to defects in materials and workmanship which occur during normal use. This warranty does not cover damage which occurs in shipment, or failures which are caused by products not supplied by the warrantor, or failures which result from accident, misuse, abuse, neglect, mishandling, faulty installation, misapplication, improper insertion of consumables, set-up adjustments, maladjustment of consumer controls, improper operation or maintenance, alteration, modification, power line surge, improper voltage supply, commercial use, or service by anyone other than an IonLife authorized repair facility, or damage attributable to acts of God. Limits and exclusions: there are no express warranties except as listed above.

The warrantor is not responsible for incidental or consequential damage; for damages arising out of the use of any unauthorized attachment; or for damages resulting from the use of the product with a defective water faucet and/or water that is judged by the local authorities as "hard" (TDS above 18grains),.

All express and implied warranties, including the warranties of merchantability and fitness for particular purpose, are limited to the applicable warranty period.

Repair and/or replacement will be at the final discretion of IonLife.

For additional information, operating assistance, literature request and all other inquiries please contact your dealer.

MEMO

MEMO

ALKALINE IONIC WATER SYSTEM

